

Varenummer: 2031100M24125B3T
 Beskrivelse: E+G Justerfod
 GN 31-100-M24-125-B3-T
 Note: T Uden møtrik, spændeflade i bunden

Mål

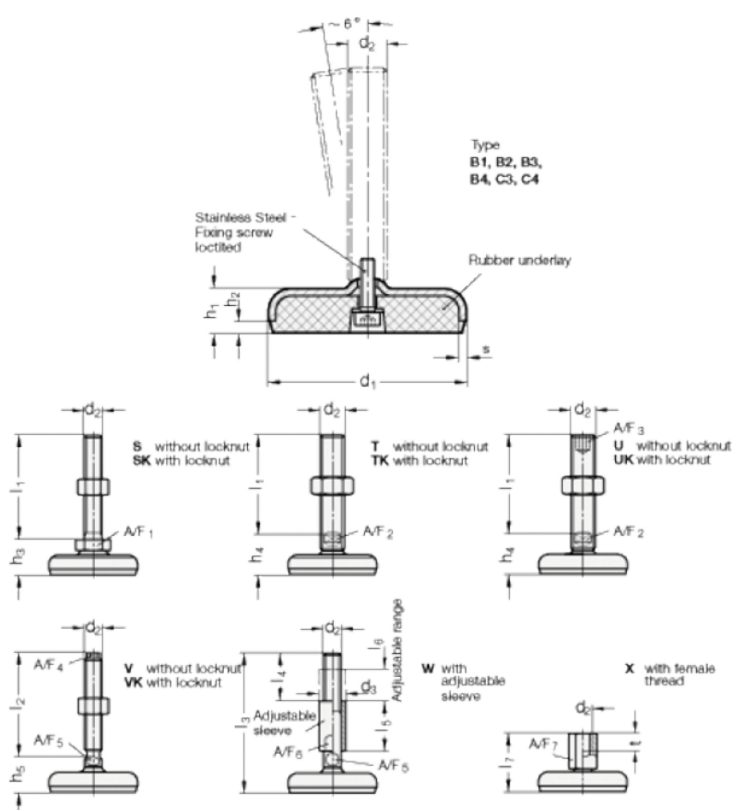

A/F2	= 19
d1	= 100
d2	= 24
h1	= 20
h2	= 6
h4 +4.0/0	= 38
l1	= 125
s	= 3